

NPK

DG-9 STD DEMOLITION GRAB GENERAL DIMENSIONS

CONSTRUCTION EQUIPMENT, INC.

7550 INDEPENDENCE DRIVE
WALTON HILLS, OHIO 44146
PHONE: (440) 232-7900
FAX: (440) 232-4382

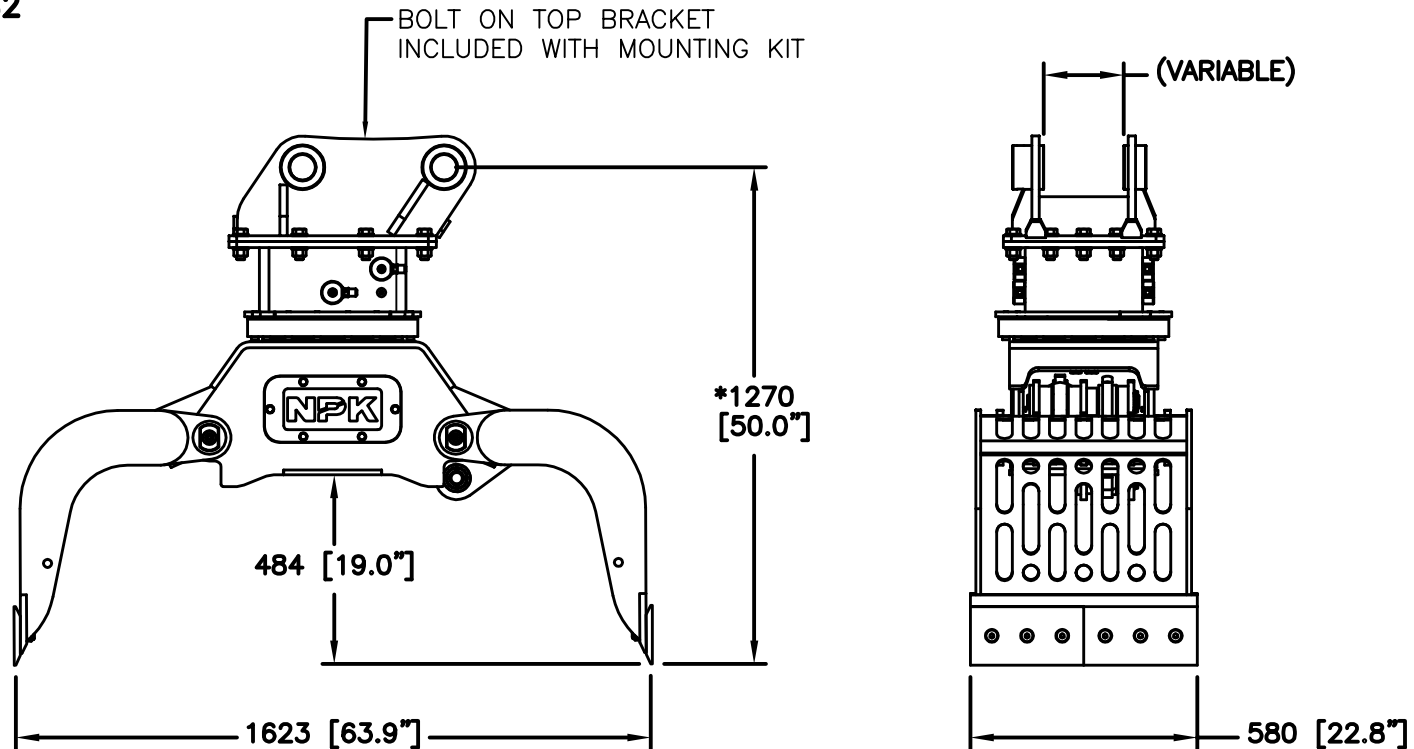

DO NOT SCALE DRAWING

SPECIFICATIONS SUBJECT TO CHANGE WITHOUT NOTICE

* THIS DIMENSION MAY DIFFER ON SOME ASSEMBLIES DUE TO TOP BRACKET VARIATION.