

# NPK

## DG-4 STD DEMOLITION GRAB GENERAL DIMENSIONS

CONSTRUCTION EQUIPMENT, INC.

7550 INDEPENDENCE DRIVE  
WALTON HILLS, OHIO 44146  
PHONE: (440) 232-7900  
FAX: (440) 232-4382

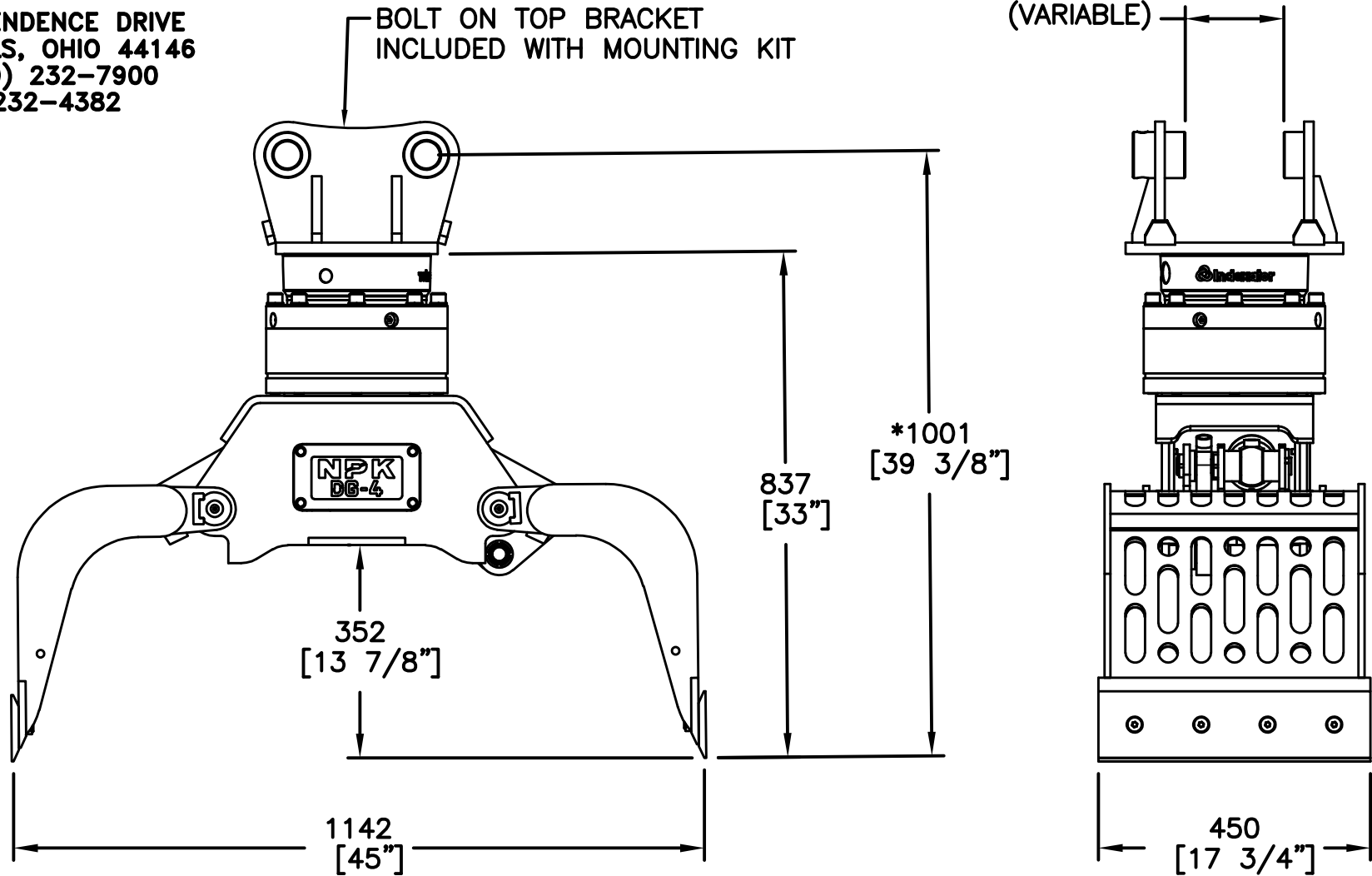

DO NOT SCALE DRAWING

SPECIFICATIONS SUBJECT TO CHANGE WITHOUT NOTICE

\* THIS DIMENSION MAY DIFFER ON SOME ASSEMBLIES DUE TO TOP BRACKET VARIATION.